









Dive into your next dimension

AIRONE

AIRONE 300 MESH
Instructions manual

A Package details

 x 8	 x 6	 x 4
Motherboard screw	The power screw	HDD screws(6#*5)
 x 4	 x 4	 x 4
HDD screws(6-32)	Copper pillar	Hard disk shock pad
 x 5		
Cable Tie		

B Schematic diagram of wire interface

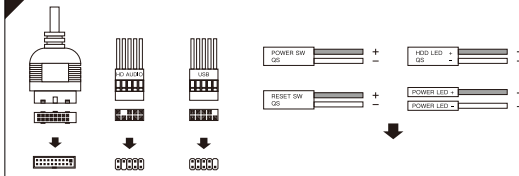

Please refer to the manual that came with your motherboard for any specific connection instructions

C Product size

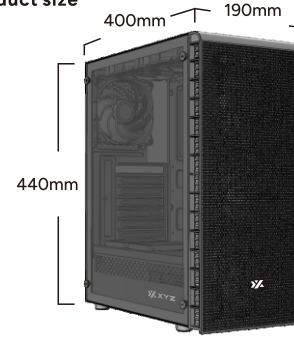

D IO panel introduction

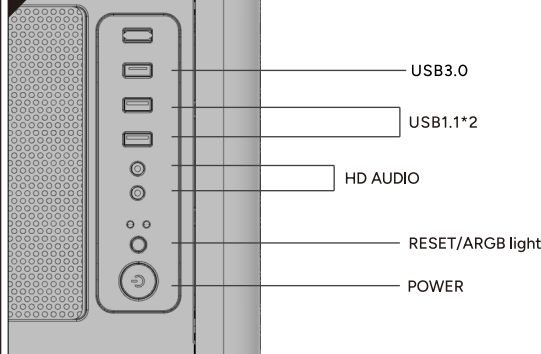

E Machine overview

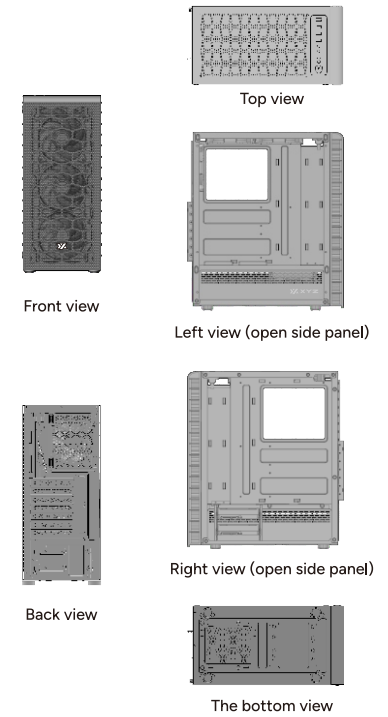

F Chassis disassembly diagram

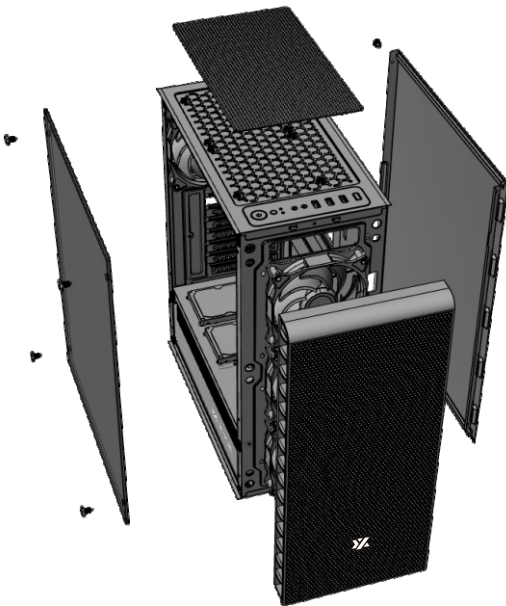

G Remove and install side panels

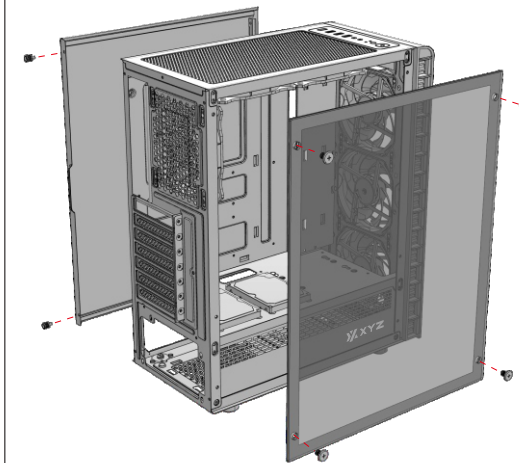

Glass side panel installation:
Fix the glass side panel with 4 screws (as shown above)
Metal side plate installation:
Buckle the side plate and fix it with two screws

H The power supply installation

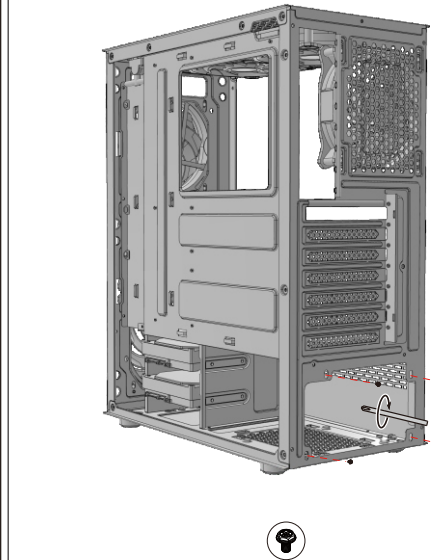

The power supply can be fixed by aligning the screw in the figure to the hole position
Note: different types of power supply, hole location may be slightly different, take the actual object as the standard

I Motherboard installation

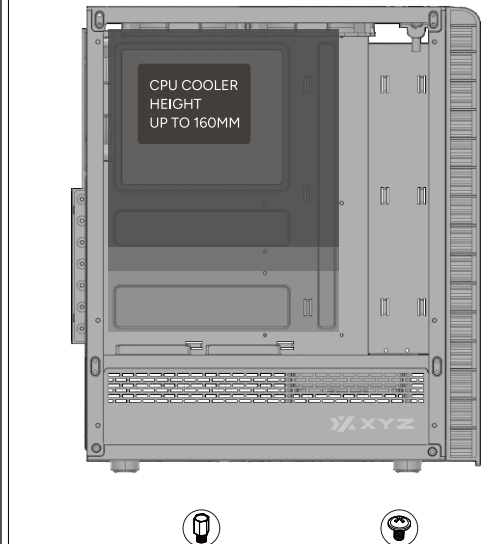

According to the motherboard type (ATX/M-ATX/ITX), the copper pillars may need to be re-arranged manually according to the fixing locations specific to your motherboard
CPU Height limit: 160mm

J The graphics card installation

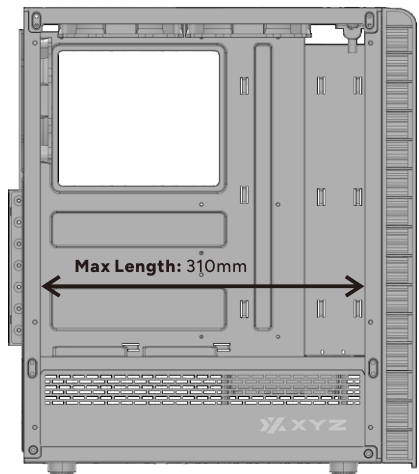

K Panel disassembly

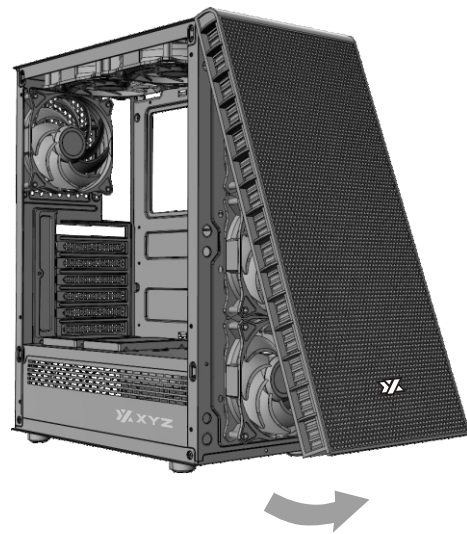

To remove the front panel of the case, pull it by hand, firmly from the bottom of the panel

L Fan installation

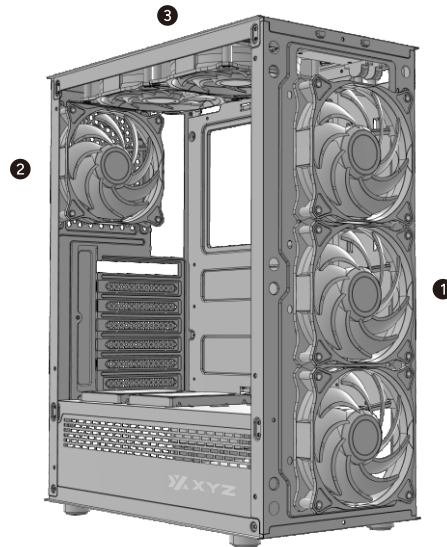

Fan compatibility

- ① Front: 3 x 120/2 x 140mm
- ② Rear: 1 x 120mm
- ③ Top: 2 x 120mmmm

M Water cooling installation

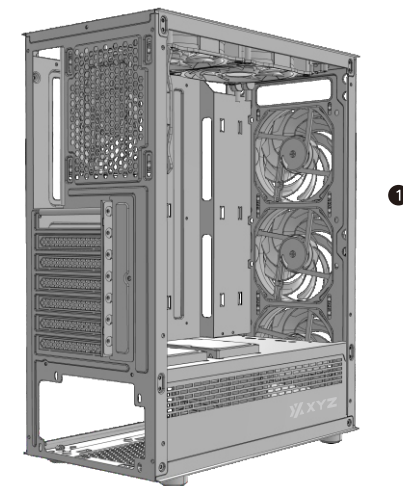

Radiator Support ① Front: 240mm

N SSD installation

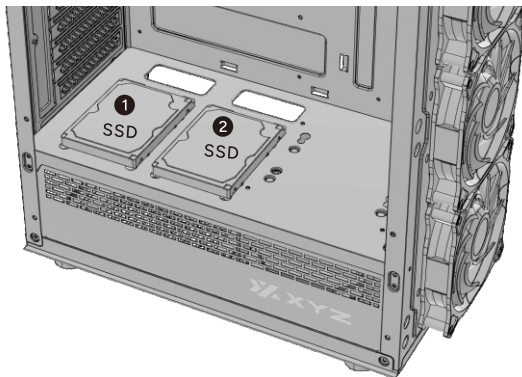

2*SSD

Align the SSD holes and fix them with screws.

O HDD installation

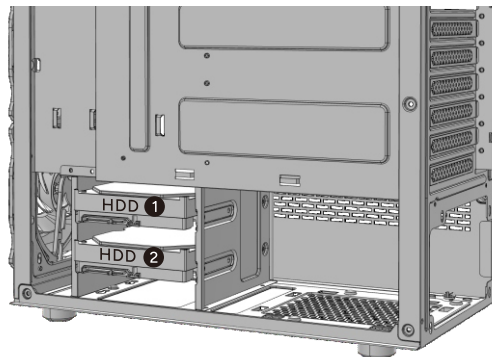

2*HDD

Align the hard disk holes and fix them with HDD screws.

P Controller user instruction

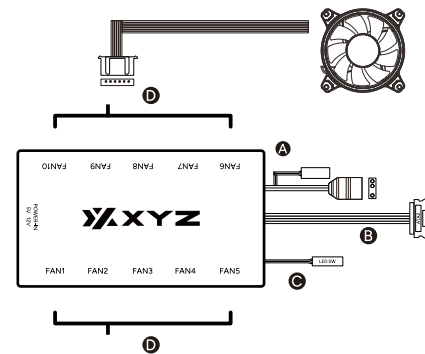

- Ⓐ Universal link to motherboard 5V 3pin connector.
To use this feature, hold down the reset key for 5 second.
- Ⓑ SATA power connector (PSU).
- Ⓒ Can switch to the computer LED button.
- Ⓓ Support 10pcs FANS.

XYZ



Find out more about us at
www.xyzpcgear.com